

CELL-12-TRIO

LED Module and Driver Set



Description

The CELL TRIO series are a plug and play LED lamp module and LED driver set. They are the perfect solution for residential homes to commercial projects such as hotels, clubs, pubs and bars. Designed not only as a replacement for traditional halogen lamps in most applications, but also as a replaceable LED lamp and driver set for a range of click in frames, as a complete downlight solution. For retrofit, it's as easy as removing the standard MR16 halogen lamp and transformer and replacing it with the CELL lamp and LED driver. It suits most MR16 downlight frames, depending on height.

As a complete lamp and frame solution, simply choose from a range of click in frames on offer to suit the style and décor. Featuring a reflector style lens with a choice of 15°, 24°, 36° or 60° beam angle effects to suit ceiling heights or lighting effects. Available in 9W, 12W and 15W options depending on the light intensity required. Now with TRIO, the added option of changing the colour temperature output of the LED lamp module with a dip switch on the LED Driver. With the choice of Warm White, Neutral White or White colour temperature options to suit the desired light appearance. Complete with dimmable LED driver and flex and plug. Backed by our Three Year Replacement Warranty.

Specification Features

- Input Voltage: 240V
- Power (W): 12
- IP rating (IP): 44*
- Lumens (lm): Warm White 3000K - 870lm
Neutral White 4000K - 1000lm
White 5700K - 990lm
- LED type: COB
- CCT: 3000K - 4000K - 5700K (Switchable)
- CRI: ≥80
- Beam angle (°): 15°/24°/36°/60°
- Dimmable: Yes**
- Lifespan (hrs): 50,000hrs

* IP44 rating is from the underside of the down light once installed into the ceiling.
** Tested on the Domus dimmer series. May work on others but not tested.

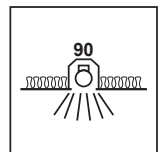

Diagrams / Additional

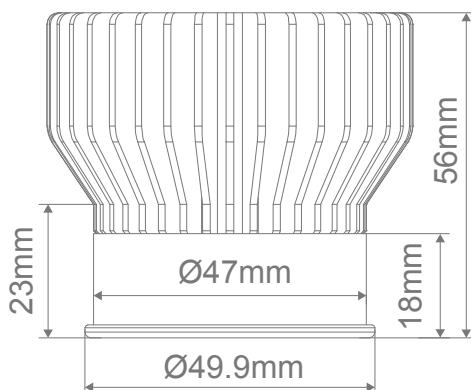

Item No.	Variant	Colour	Beam Angle (°)
CELL-12-TRIO	27066	TRIO	15°
	27067		24°
	27068		36°
	27069		60°



CELL 12 Series Multi Frame Solution



Combine the power of one module with multiple frames

Assembly

Module

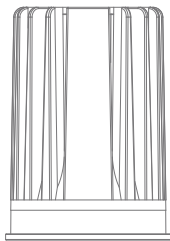

Press down firmly until module clicks into frame.

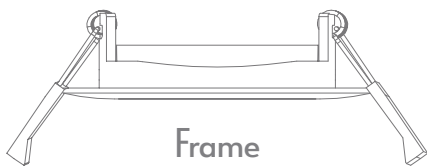

Frame

Available Frames

DEEP-75

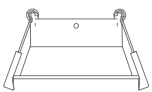

DEEP-90

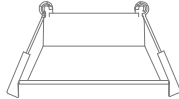

TILT-75

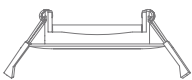

TILT-90

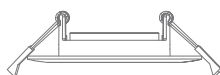

KEY-75 & PIN-75



WALL-90

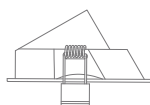

SLOT-1

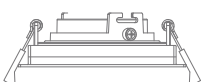

SLOT-2

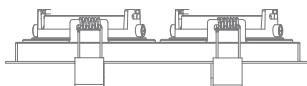

DEEPCELL-75-12W



DEEPCELL-90-12W



TILTCELL-75-12W



TILTCELL-90-12W



KEYCELL-75-12W



PINCELL-75-12W



WALLCELL-90-12W



SLOTCELL-1-12W



SLOTCELL-2-12W



CELL 12 Series Multi Frame Solution



Combine the power of one module with multiple frames

Assembled

Module

Item No.	Variant	Colour	Beam Angle (°)
CELL-12	27066	TRIO	15°
	27067		24°
	27068		36°
	27069		60°

Frames

Item No.	Variant	Frame Colour
DEEP-75	27048	White
	27049	Black
DEEP-90	27050	White
	27051	Black
TILT-75	27052	White
	27053	Black
TILT-90	27054	White
	27055	Black
KEY-75	27064	White
	27065	Black
PIN-75	27062	White
	27063	Black
WALL-90	27056	White
	27057	Black
SLOT-1	27058	White
	27059	Black
SLOT-2	27060	White
	27061	Black

DEEPCELL-75-12W

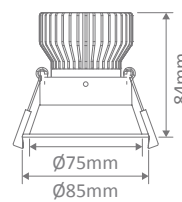

Cutout: Ø75-77mm

DEEPCELL-90-12W

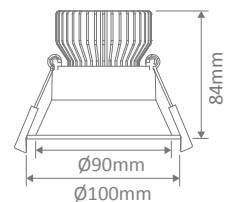

Cutout: Ø90-92mm

TILTCELL-75-12W

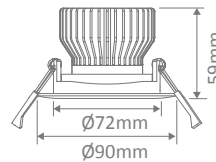

Cutout: Ø72-75mm

TILTCELL-90-12W

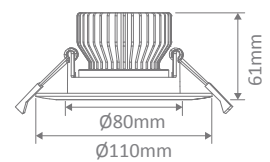

Cutout: Ø80-85mm

KEYCELL-75-12W

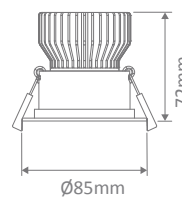

Cutout: Ø70-75mm

PINCELL-75-12W

WALLCELL-90-12W

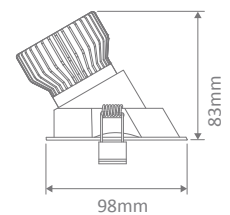

Cutout: Ø88-90mm

SLOTCELL-1-12W

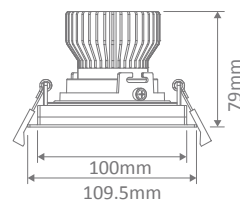

Cutout: L100mm x W100mm

SLOTCELL-2-12W

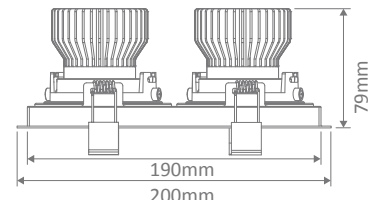

Cutout: L190mm x W100mm