

Neon Flex

- 
IP68
INGRESS PROTECTION
- 
3y
YEARS WARRANTY
- 
SALTWATER RESISTANT
- 
SOLVENT RESISTANT
- 
ULTRA VIOLET PROTECTION
- 
3s
STEP MACADAM
- 
HORIZONTAL BENDING
- 
LM80
LUMEN MAINTENANCE
- 
24V DC
OBSERVE POLARITY

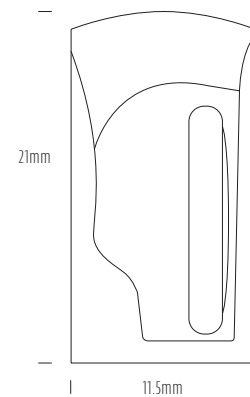
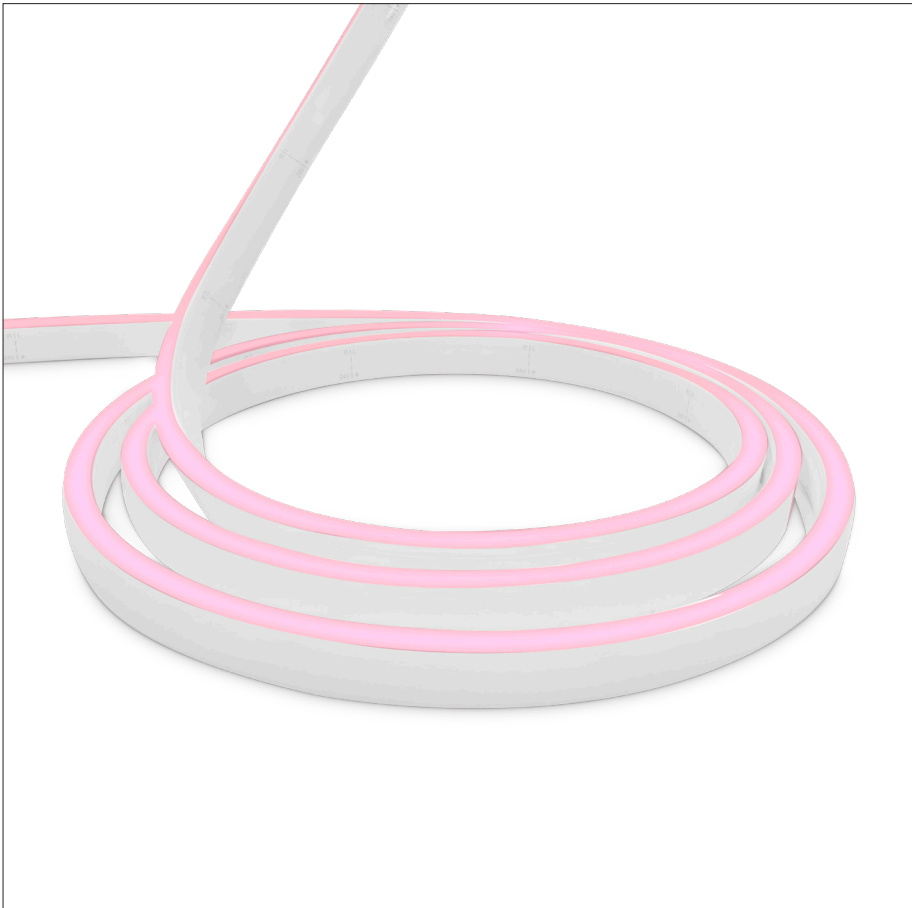

| Product | AQS-500-RGB |
|--------------------------------|--|
| Voltage | 24V DC |
| Watts (per Meter) | 12W |
| IP Rating | IP68 |
| Lumen Output (per Meter) | TBA |
| CCT & Colour Options | RGB |
| Working Mode | Constant Voltage (PWM) / DMX |
| Max Length (Single Power Feed) | 10m |
| Max Length (Double Power Feed) | 20m |
| Cut Interval | 100mm |
| Bend Direction | Horizontally |
| Minimum Bend Diameter | 80mm |
| LED Type | SMD5050 |
| LED Qty / M | 60pcs |
| Lumen Maintenance | 70,000 Hours L70@ 25°C, 50,000 Hours L70@ 50°C |
| Materials | Eco PVC |
| Emission Angle | 120° |
| Operating Temperature | -20° to +40°C |
| Installation Temperature | 5° to +35°C |
| Warranty | 3 Year Aqualux Warranty |

Production Tolerances

The AQS-500 series Neon Flex product is manufactured in a continuous extrusion process and then manually terminated with IP68 overmolded cable entry points. Production tolerances need to be accounted for during site preparation.

- < 1M ±5mm
- < 5M Length ±10mm
- < 10M Length ±15mm
- < 20M ± 20mm

Refer to installation guide when planning your project.

Dimming Options

PSU Control (PWM / Phase / Remote)
24V Control (PWM)

For wiring diagrams please refer to the aqualux website: www.aqualux.com.au / Support / Downloads / Wiring Diagrams

1300 662 644
sales@aqualux.com.au



Visit www.aqualux.com.au for: Full product details and available options.
Order code configuration & customised datasheets. Voltage drop calculator & LED technical information.

Neon Flex

Variations

| Product Code | CCT Kelvin | Voltage Direct Current | Watts Meter | Lumens Meter | Min Run Single End | Max Run Double End |
|---------------|------------|------------------------|-------------|--------------|--------------------|--------------------|
| AQS-500-Z1A12 | RGB | 24V DC | 12W | TBA | 10m | 20m |

Bending Directions

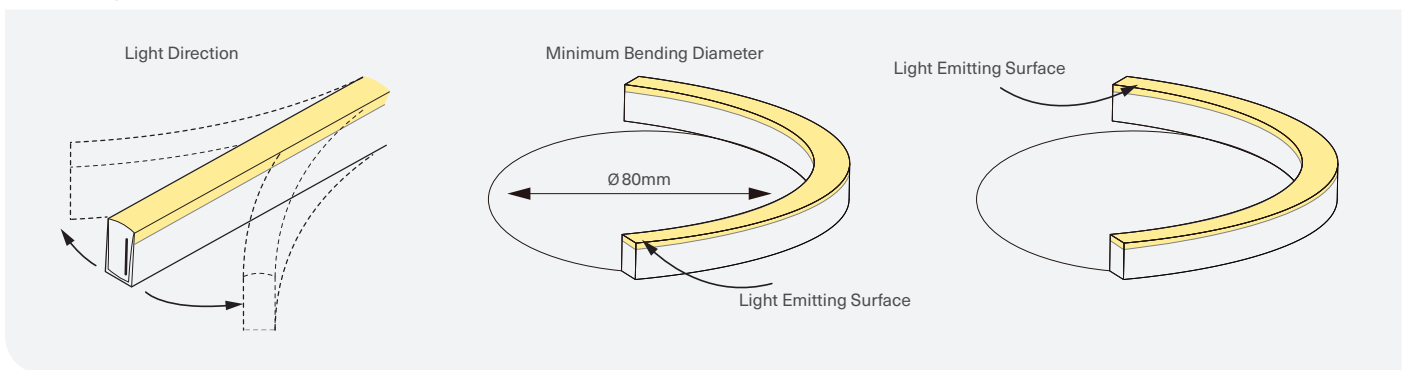

1300 662 644
sales@aqualux.com.au



Visit www.aqualux.com.au for: Full product details and available options. Order code configuration & customised datasheets. Voltage drop calculator & LED technical information.

Neon Flex

Extrusion and End Cap allowances

Assembly Notes

Direct Cable Output

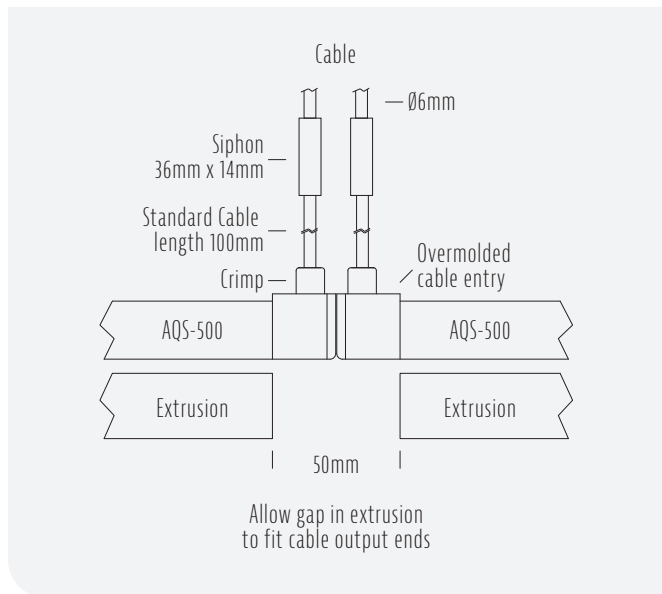

Direct Cable Output

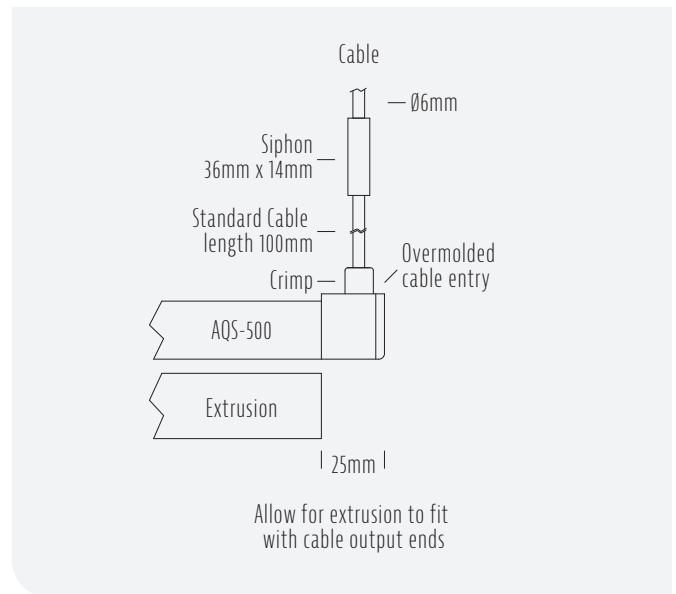

1300 662 644
sales@aqualux.com.au

Visit www.aqualux.com.au for: Full product details and available options. Order code configuration & customised datasheets. Voltage drop calculator & LED technical information.

Anti-Siphon Cable Entry Options

- Integrated non-removeable anti-siphon device
- IP68 factory assembly only
- Injection Moulded Connectors

Direct Cable Entry

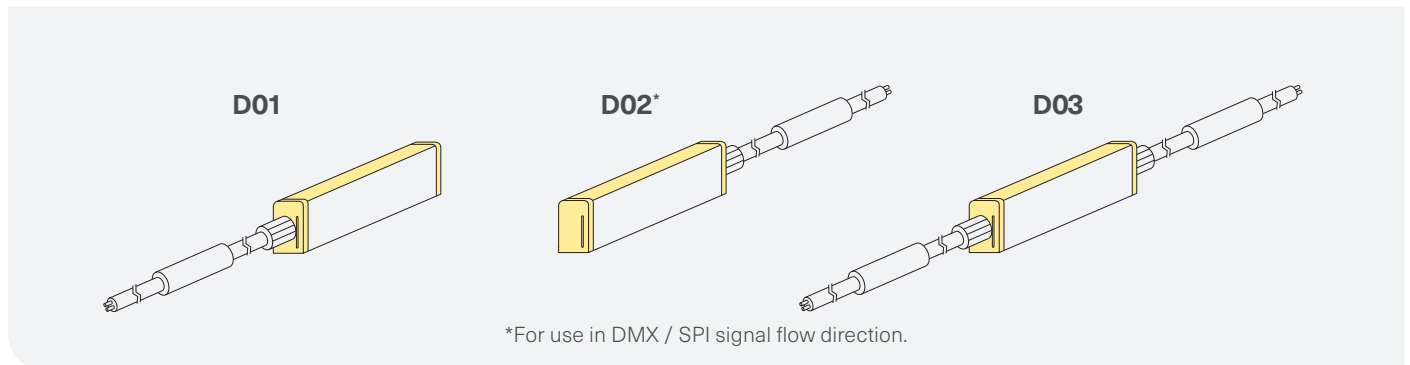

Side Cable Entry

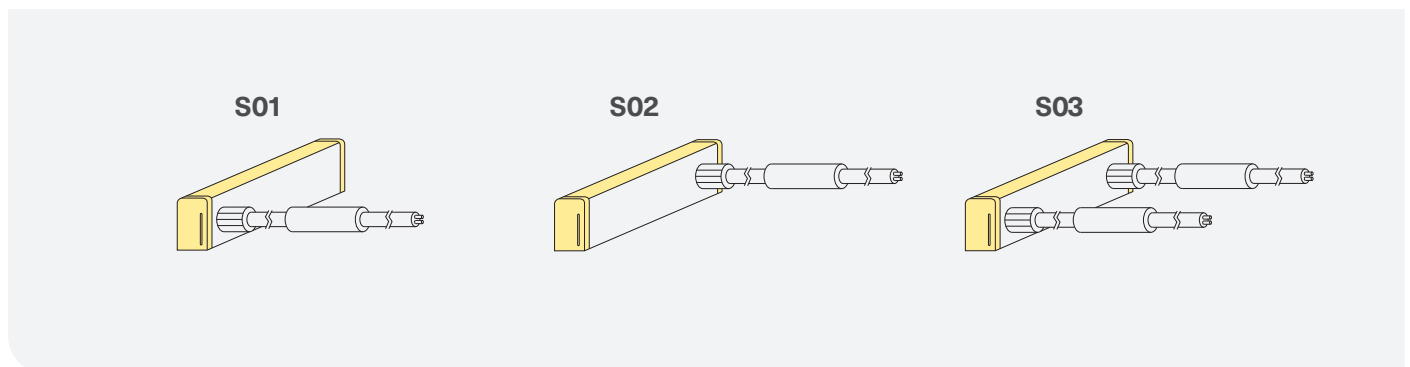

Bottom Cable Entry

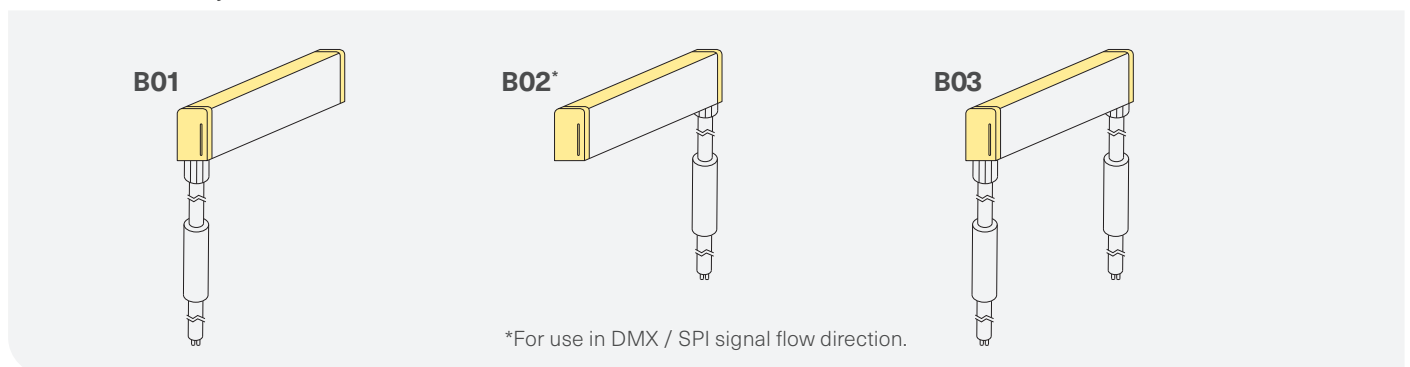

1300 662 644
sales@aqualux.com.au



Visit www.aqualux.com.au for: Full product details and available options. Order code configuration & customised datasheets. Voltage drop calculator & LED technical information.

Neon Flex

Injection Moulded Connectors Dimensions

Direct Cable Entry

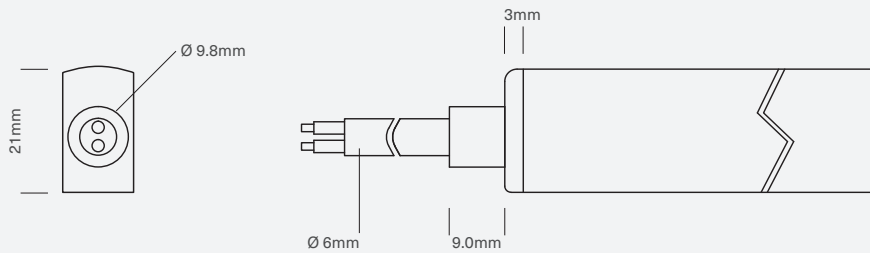

Side Cable Entry

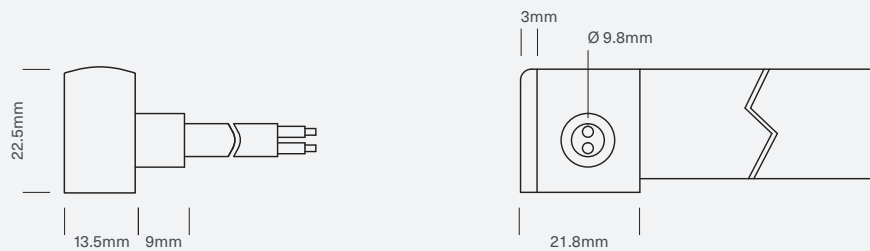

Bottom Cable Entry

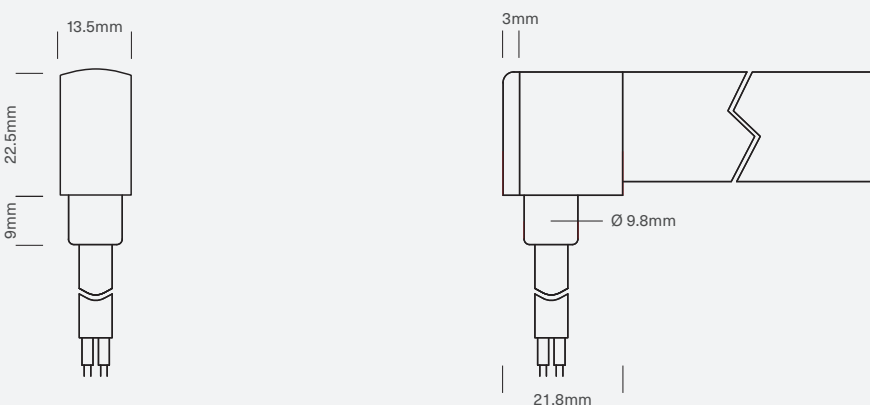

1300 662 644
sales@aqualux.com.au



Visit www.aqualux.com.au for: Full product details and available options.
 Order code configuration & customised datasheets. Voltage drop calculator & LED technical information.

Neon Flex

Charts and Diagrams

Photometric

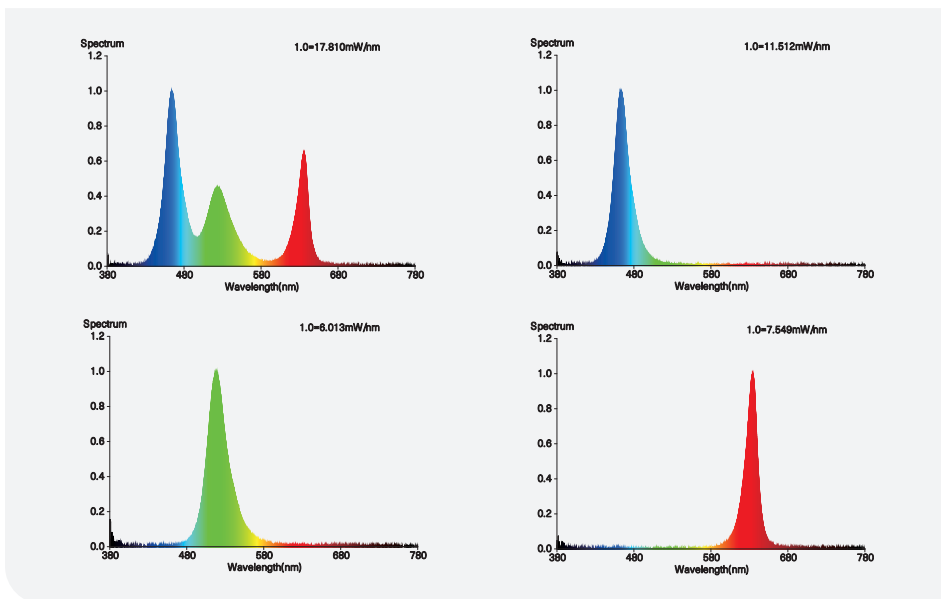

Mounting Channels

AQS-500-ACC-01 = Clip
 AQS-500-ACC-AL-01 = 1m
 AQS-500-ACC-AL-02 = 2m

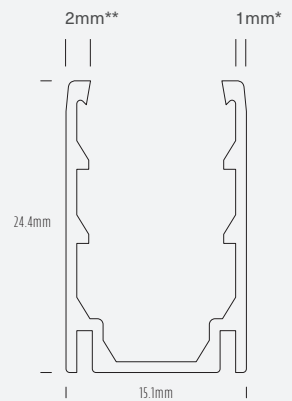

*1mm thick wall.
 **2mm thick wall including grip.

Not stocked
 Request order

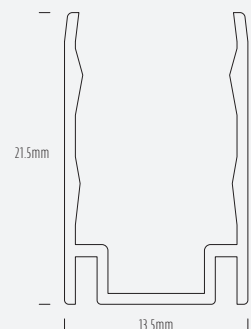

1300 662 644
 sales@aqualux.com.au

Visit www.aqualux.com.au for: Full product details and available options.
 Order code configuration & customised datasheets. Voltage drop calculator & LED technical information.

Neon Flex

AQS Family Reference Table

| Product | Type | IP Rating | LED Options | Size mm | Power/m | Application |
|---------|-----------|-----------|-------------------------|-------------|-----------------------|-----------------------------------|
| AQS-170 | Cob Strip | IP20 | Mono | 10mm | 10W DC | Internal / Profile required |
| AQS-260 | Classic | IP65 | Mono | 10mm | 12W AC / 15W DC | External / Profile required |
| AQS-400 | Neon Flex | IP65 | Mono | 10 x 9 | 5W DC / 10W DC | External / No profile required |
| AQS-401 | Neon Flex | IP65 | Mono | 10 x 10 | 10W DC | External / No profile required |
| AQS-410 | Neon Flex | IP65 | RGB | 13 x 12 | 10W DC | External / No profile required |
| AQS-420 | Neon Flex | IP65 | Mono / RGBW | 12 x 20 | 10W / 15W | External / No profile required |
| AQS-500 | Neon Flex | IP68 | Mono / RGB / RGBW / DMX | 11.5 x 21 | 5W / 8W / 12W / 18W | External / Submerged / No profile |
| AQS-505 | Neon Flex | IP68 | Mono | 13.5 x 13.5 | 10W | External / Submerged / No profile |
| AQS-510 | Neon Flex | IP68 | Mono / RGB / RGBW / DMX | 16.5 x 16.5 | 10W / 13W / 17W / 18W | External / Submerged / No profile |

Extension Wire Recommendations

Maximum extension wire length according to light power

| Watts | 22AWG 0.34mm ² | 20AWG 0.53mm ² | 18AWG 0.82mm ² | 17AWG 1.04mm ² | 16AWG 1.38mm ² | 14AWG 2.07mm ² | 12AWG 3.29mm ² | 10AWG 5.62mm ² |
|-------|------------------------------|------------------------------|------------------------------|------------------------------|------------------------------|------------------------------|------------------------------|------------------------------|
| 10W | 36m | 60m | 100m | 120m | 140m | 240m | 400m | 600m |
| 20W | 18m | 30m | 50m | 60m | 70m | 120m | 200m | 300m |
| 30W | 12m | 20m | 30m | 38m | 45m | 80m | 130m | 200m |
| 40W | 8m | 15m | 22m | 28m | 35m | 60m | 95m | 140m |
| 50W | 6m | 12m | 18m | 22m | 28m | 48m | 75m | 105m |
| 60W | 5m | 10m | 15m | 18m | 22m | 36m | 60m | 88m |
| 70W | - | 8m | 12m | 14m | 18m | 30m | 50m | 72m |
| 80W | - | 6m | 10m | 11m | 14m | 24m | 40m | 58m |
| 90W | - | 4m | 7m | 8m | 10m | 18m | 30m | 45m |
| 100W | - | - | 5m | 6m | 7m | 12m | 22m | 32m |
| 110W | - | - | 3m | 4m | 5m | 8m | 15m | 22m |
| 120W | - | - | 2m | 2.5m | 3m | 0m | 8m | 12m |



1300 662 644
sales@aqualux.com.au

Visit www.aqualux.com.au for: Full product details and available options.
Order code configuration & customised datasheets. Voltage drop calculator & LED technical information.