

Fixed pathlight

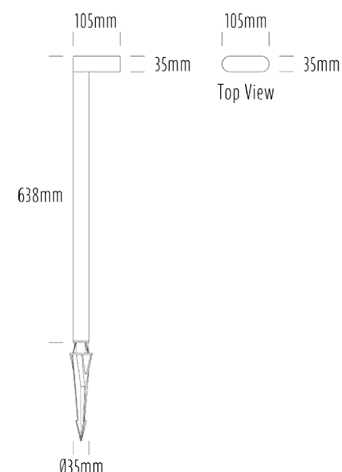

SPECIFICATIONS

Product Code	AQL-120
Family	Lumena
Construction Material	CNC Machined Aluminium
IP Rating	IP65
Warranty	5 Year Aqualux Warranty

CONFIGURED OPTIONS

Variant Code	AQL-120-A2X00430DFQ
Body Colour	Dulux Black Ace 9069116F
Control Gear	12~24V AC / 24V DC
Rated Power	4W
Nominal Lumens	300 lm
CCT / Colour	3000K / 300mA
Optical	DF
CRI	90
Other	AqualuxPLUS QuickConnect
Dimming	Optional 10V PWM (DC)

INTRODUCTION

The AQL-120 is a minimalist offset path light, with an integrated LED and diffuse glass cover for spreading light evenly and smoothly across a pathway. Available October 2020.



1300 662 644
sales@aqualux.com.au