

Micro Spike Light

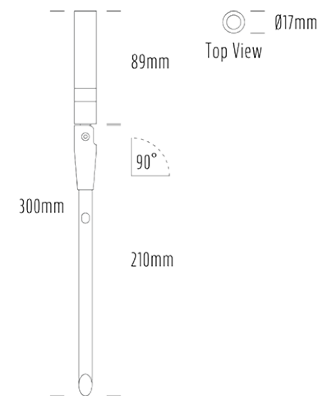

SPECIFICATIONS

Product Code	AQL-116
Family	Lumena
Construction Material	CNC Machined Aluminium
IP Rating	IP65
Warranty	5 Year Aqualux Warranty

CONFIGURED OPTIONS

Variant Code	AQL-116-A1X0025730Q
Body Colour	Satin Chrome Anodize
Control Gear	12~24V AC / 24V DC
Rated Power	2W
Nominal Lumens	150 lm
CCT / Colour	5700k / 500mA
Optical	30
CRI	90
Other	AqualuxPLUS QuickConnect
Dimming	Optional 10V PWM (DC)

INTRODUCTION

A micro sized adjustable spike light for planter boxes and anywhere discrete, optically controlled spotlighting is required. Available October 2020.



1300 662 644
sales@aqualux.com.au